



MOY-KA!DS Portal

№1 self-service car wash
chain in Russia

Welcome to our catalog

10

10 years of experience that we will share with you

50

50 types of equipment worked out to the smallest detail

10

10 industries that use our equipment

Contents

About company	4
DS 360	8
Benefits	10
Installation drawing	12
Geography	14
Contact us	16

MOY-KA!DS Business

4e, Brusilova st.,
Voronezh,
Russia

8 800 350 15 81

dscarwash.ru

Why us?

MOY-KA!DS Business is a group of companies which includes the largest federal chain of self-service car washes MOY-KA! DS and DS Industry—production and sales of equipment and components for car wash complexes with exclusive proprietary software.

Our benefits:



24/7 service and warranty

24/7 service and extended warranty for all types of components. Replacement of components is faster and more stable due to minimal risks of supply interruptions. Free customer service call in case of any malfunction within warranty cases (up to 5 years).



Mobile app

Possibility of integration with any mobile application of the customer.

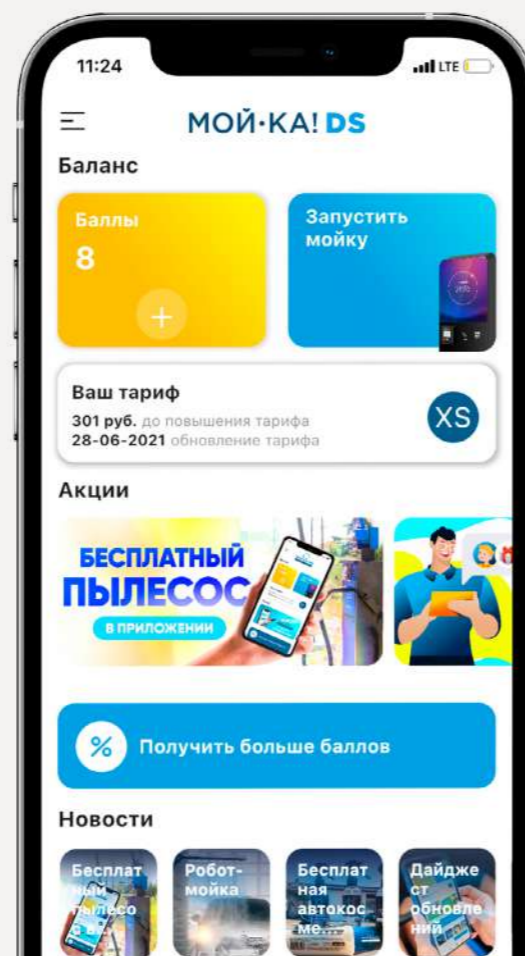

Unique formula of the chemicals

We have our own production-based laboratory that produces automotive chemicals. Therefore, their cost will be significantly lower than the competition and of better quality, as the company builds long-term relationships with owners and provides a full range of services related to the development of the chain.



Saving

Significant savings in electricity, water and chemicals compared to the basic Leisu wash equipment (basic programs don't take into account changes in demand due to geographical and climatic features, and also don't have the ability to read car dimensions, wasting electricity and detergents).



Quality

Quality components from German and Italian manufacturers. Import of components directly from factories in Germany (R+M) and Italy (Komatsu), increased wear resistance compared to the competitors using completely Chinese mechanisms.



Monitoring system

3D Smart monitoring system



You can choose

Two types of terminals – hinged and floor standing. Tempered glass and custom branding.



Water treatment system

Individual approach to the water treatment system depending on water characteristics.

We can do anything

Customize your Self-service car wash.



Software features:



Selecting the direction of the rotary arm movement



Changing the speed and duration of each program



Program cycle control



Sleeve direction control



Sensitive sensors that recognize car body features



Extended functionality of the electronic display in the wash bay



Remote start of washing from the car by QR code reading



Changing the washing program constructor

DS 360



Two types of terminals – hinged and floor standing. Tempered glass and custom branding.



Robot







Basic

+ Extra

Included in the basic equipment

Purchased separately

Programs

-  **Bottom washing**
-  **Side washing of wheels and**
-  **Chemicals**
-  **Side foam**
-  **Streaks-free rinse**
-  **Wax**
-  **Drying system built into the portal**

- Payment terminal**
- Automatic gate control unit**
- Water treatment system (softener)**
- Reverse osmosis system**

Options

- Voice notification**
- Parking assistance system**

	Water consumption per 1 wash bay	300-500 l
	Working water pressure	70-100 bar
	Power consumption per 1 wash bay	35-45 kW
	Power Options	3/380/50 (Ph/V/Hz)
	Built-up area	7100*4000*3100 (L/W/H)

Advantages of Russian-made DS 360 automatic car wash



In-house developed and configured single control panel.



Chassis washing + wheel arches washing + car body side washing at the entrance to the washing bay.



Completely proprietary software with the possibility of any configuration of washing programs.



Convenient layout of the portal elements for further maintenance.



Chemical block for 4 chemical programs using Dosatron: 2 types of chemicals and wax from the main hose + side feed of chemicals.



High pressure osmosis feed with adjustable pressure.



Much of the components are Russian-made (metal structures, engines, drive mechanism of the portal, control module, etc.).



Free flashing when a software update is released.



Installation drawing

Portal DS 360

This type of equipment is a fully automated complex for touchless car washing. The process doesn't require operator involvement, which significantly reduces personnel costs, and also minimizes the risks associated with the competence of specialists.

At the same time, the average bill for a contactless type car wash is higher compared to a self-service complex, which guarantees a high rate of return on the project. Individual setting of washing programs, remote control and optimization of water, car chemicals and electricity consumption provide the business with competitive advantages.

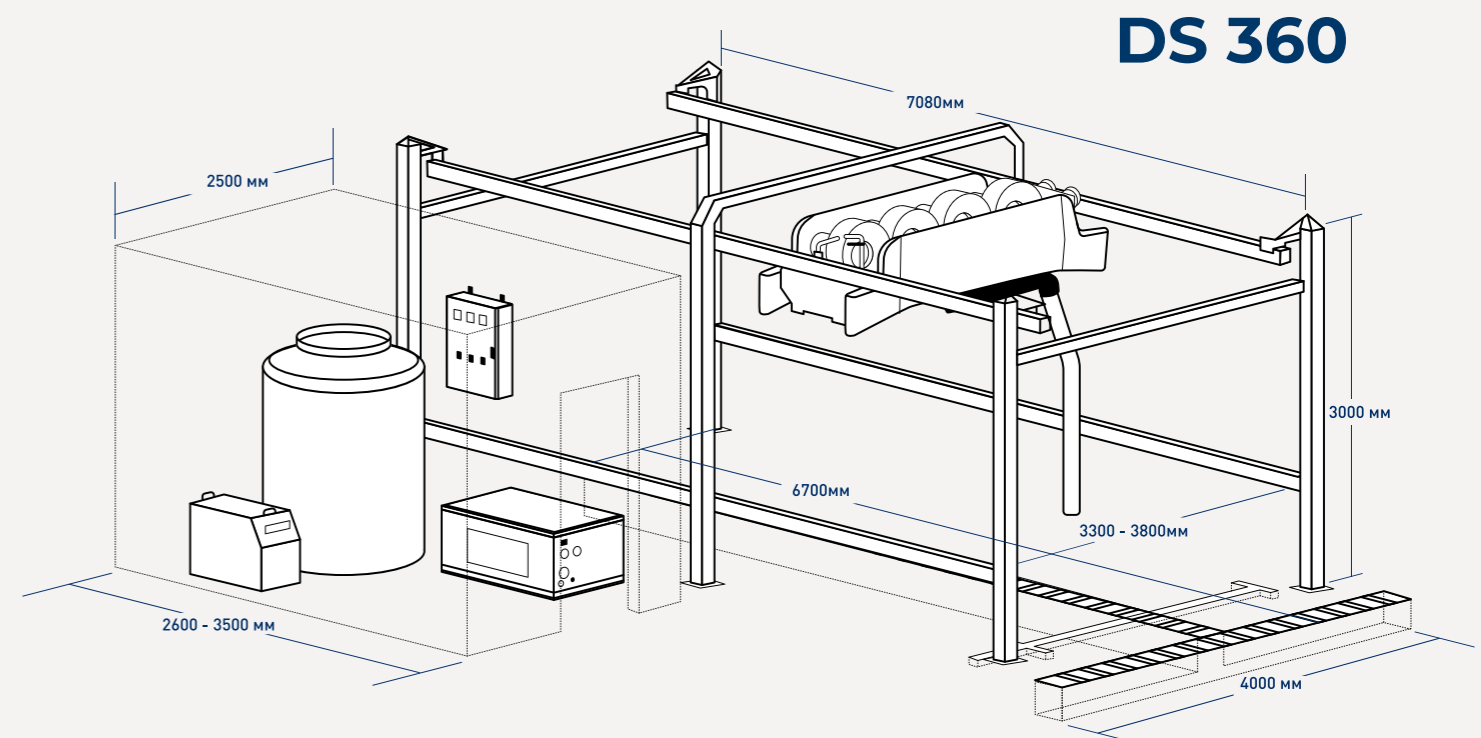



Our geography

17
self-service car washes abroad

192
self-service car washes in Russia

-  Location of self-service car washes
-  Head office and production in Voronezh
-  Our branches: Moscow, Rostov-on-Don

Our equipment sets in Russian cities:

Moscow, Lytkarino, Khimki, Serpukhov, Pavlino, St. Petersburg, Kirishi, Gatchina, Tyarlevo, Murmansk, Pskov, Smolensk, Vladimir, Lipetsk, Gryazi, Belgorod, Tambov, Penza, Kuznetsk, Voronezh, Liski, Boguchar, Pavlovsk, Astrakhan, Rostov-on-Don, Volgograd, Saratov, Balakovo, Samara, Kazan, Yakutsk

Contact us



**4e, Brusilova st.,
Voronezh**

Address of our office
and production

8 (800) 350-15-81

Phone number for
getting advice

sales@dscarwash.ru

Email address for your
emails



Visit our website
www.dscarwash.ru

**Contact us to receive
detailed animated
instruction on how to use
our automatic car wash
for your customers.**

